

Technical data sheet

SELF PP Plastic Channels



ANRIN

SERVICE provides custom solutions and possibilities for the contract business. Here you benefit from reliable cooperation with our technical office staff and good contact with the field staff. ANRIN is certified according to DIN EN ISO 9001:2008.

ANRIN DIRECT CONTACT: +49 (0) 29 47.97 81-0

Product specifications

Produktspezifikationen	PP Channels 070, 0100, 0150	PP Sump unit 0100, 0150
Material	Plastic	Plastic
Length	100 cm	50 cm
Width	13.1 cm	13.1 cm
Height	7 cm / 10 cm / 15 cm	28 cm / 33 cm
Weight	1.6 kg - 3.2 kg	1.6 kg - 2.1 kg
Nominal width	100 mm	100 mm
Slope type	Constant invert	Constant invert
Joint type	UNILINK® joint	UNILINK® joint
Fastening	TwistLock fastening	TwistLock fastening
Load capacity	A 15	A 15
Cover gratings	Slotted steel grating cl. A15, plastic grating cl. A15	Slotted steel grating cl. A15, plastic grating cl. A15

Material properties

Physical properties of polypropylene	Chemical properties of polypropylene
High resistance to breaking	Resistant to road salt
High impact strength	Resistant to acids
Thermally stable from -20 °C to +95 °C	Resistant to alkalis and most organic solvents
Elastic modulus 1300 to 1800 N/mm ²	High UV stability
Density 0.895 to 0.92 g/cm ³	No emissions into the groundwater

Channel dimensions



Accessories dimensions

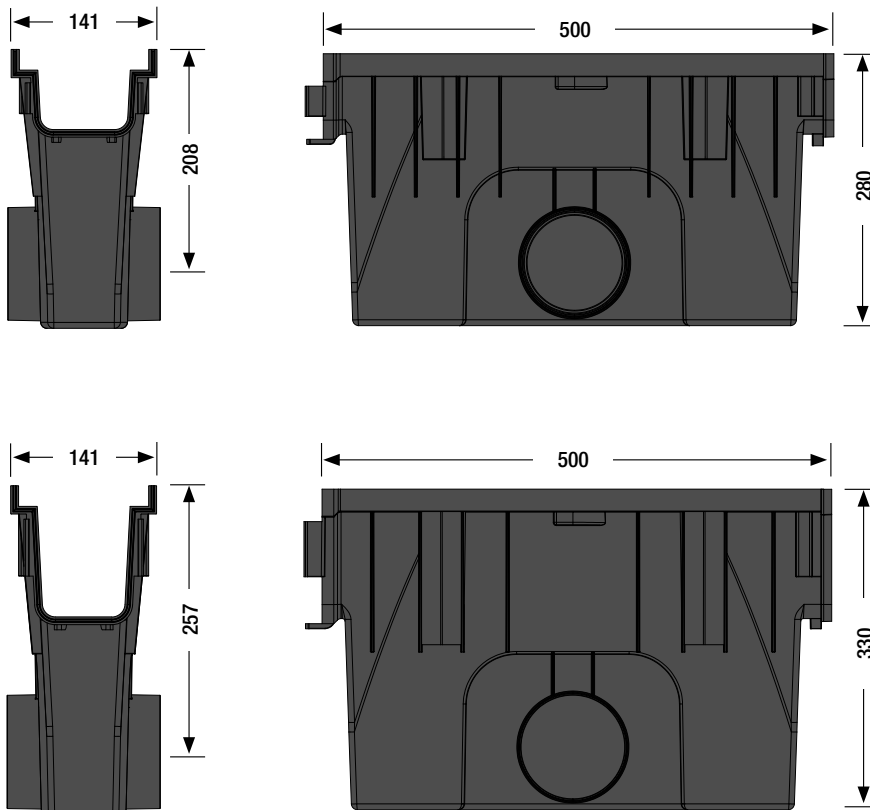

Channel types

Article no.	EAN	Designation	Length cm	Width cm	Height cm	Weight kg
11071000	4026857028017	SELF PP Channel 070 with plastic grating A15	100	13.1	7.0	1.6
11101000	4026857028055	SELF PP Channel 0100 with plastic grating A15	100	13.1	10.0	1.8
11151000	4026857028116	SELF PP Channel 0150 with plastic grating A15	100	13.1	15.0	2.1
11072000	4026857028024	SELF PP Channel 070 with slotted steel grating A15	100	13.1	7.0	2.7
11102000	4026857028062	SELF PP Channel 0100 with slotted steel grating A15	100	13.1	10.0	2.9
11152000	4026857028123	SELF PP Channel 0150 with slotted steel grating A15	100	13.1	15.0	3.2

Accessories

Article no.	EAN	Designation	Length cm	Width cm	Height cm	Weight kg
11106100	4026857028079	SELF PP Sump unit 0100 with plastic grating A15	50	13.1	28.0	1.6
11156100	4026857028130	SELF PP Sump unit 0150 with plastic grating A15	50	13.1	33.0	2.1
11106200	4026857028086	SELF PP Sump unit 0100 with slotted steel grating A15	50	13.1	28.0	1.6
11156200	4026857028147	SELF PP Sump unit 0150 with slotted steel grating A15	50	13.1	33.0	2.1
11077700	4026857028451	SELF PP end cap set 070 consisting of 2 end cap				
11107700	4026857028468	SELF PP end cap set 0100 consisting of 2 end cap				
11157700	4026857028475	SELF PP end cap set 0150 consisting of 2 end cap				

Installation instructions

The following installation guidelines are schematic representations. These are provided as examples and are non-binding. The information provided here is based on our long-term experience in excavation and road construction as well as the state-of-the-art technology. Despite this, designers and planners are always obligated to check the products and the installation instructions for their appropriateness. The example details are simplified recommendations for execution. Constructions are to be re-created on a project-specific basis.

Important: Insert gratings for the installation.

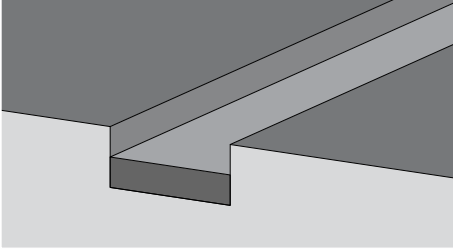
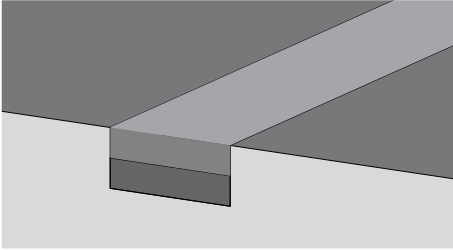
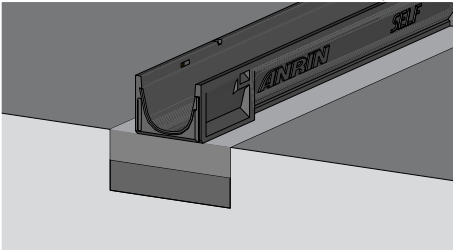
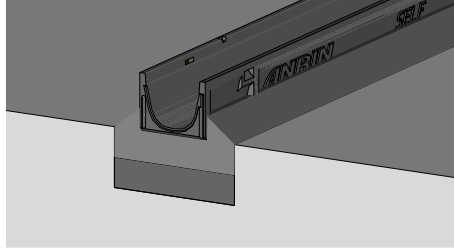
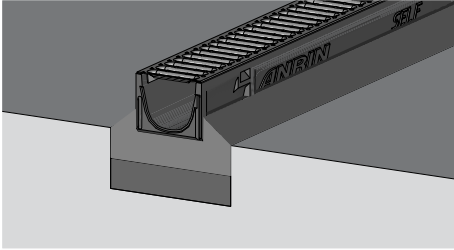
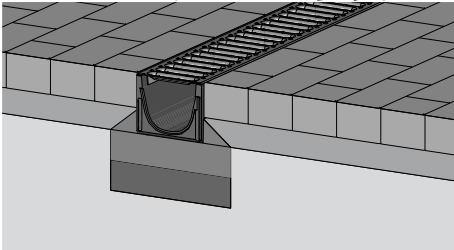
Installation instructions	
	Dig out the trench. Fill in and pre-condense the base course.
	Fill concrete, 3 parts sand + 1 part water + 1 part cement, into the base of the trench.
	Position channel string, sump unit and end cap on the concrete bed.
	Connect pipe connections to the pipeline and align the components evenly. Fill concrete bed.
	Place cover gratings on the channels.
	Install paving. The layer should end 2 to 5 mm higher than the cover grating.